

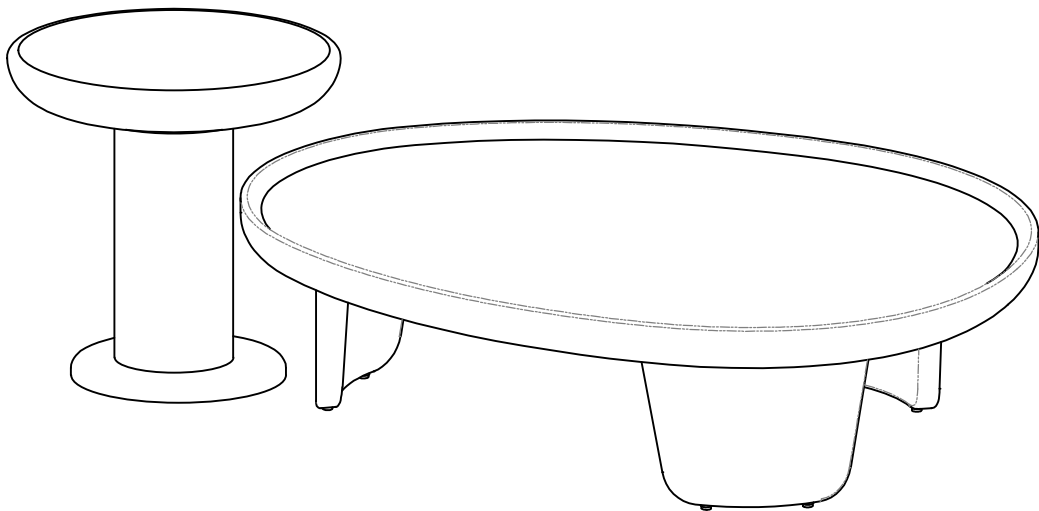

Coffee Table



CUSTOMER FIRST INTEGRITY

QEZEOMService@outlook.com

GuideTo Assembly Model:Q1540

Thank you for purchasing this product. Please read these instructions fully before starting assembly, then follow the simple step by step guide.

TOP TIPS BEFORE YOU START!

1. Please check that all parts & hardware are present before you start the assembly of your furniture. Do not destroy any of the packaging until you are certain that you have all the necessary parts for assembly.
2. For ease and speed of assembly, we recommend that before you commence each step of the assembly, please identify all the parts required for that step.
3. We recommend that where possible, all items are assembled near to the area in which they will be placed in use, to avoid moving the product unnecessarily once assembled.
4. For the protection of your furniture, particularly items of high gloss finish, we recommend that the product is placed on a protected surface during assembly to prevent any damage.
5. During assembly please take care not to over-tighten any fittings, as this may damage the product.
6. Keep children and animals away from the work area, small parts could cause choking if swallowed.

Tools Required For Assembly



DO NOT USE POWER TOOLS TO ASSEMBLE THIS PRODUCT. USE OF POWER TOOLS WILL INVALIDATE ANY CLAIM AND MAY DAMAGE THIS PRODUCT MAKING IT UNSAFE.

Rubber Hammer



Self-provided general tool diagram:

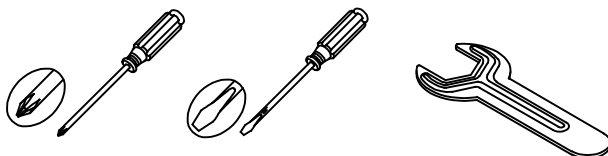

Tape Measure

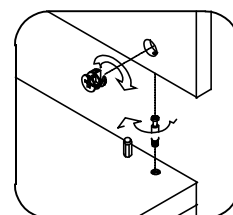
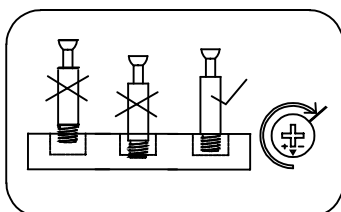

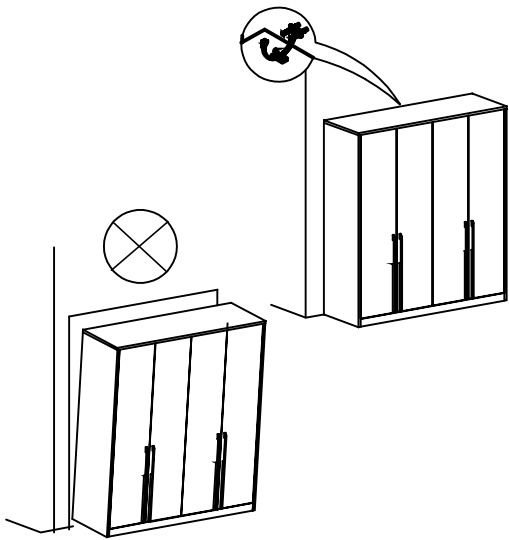

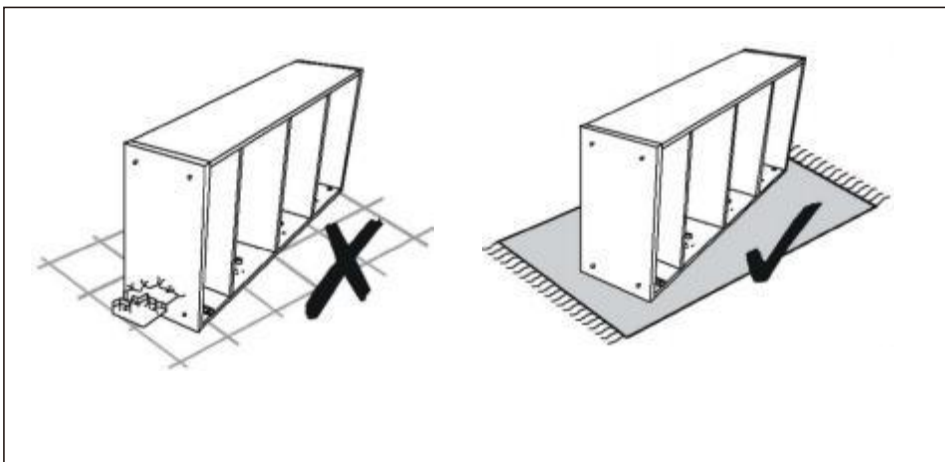
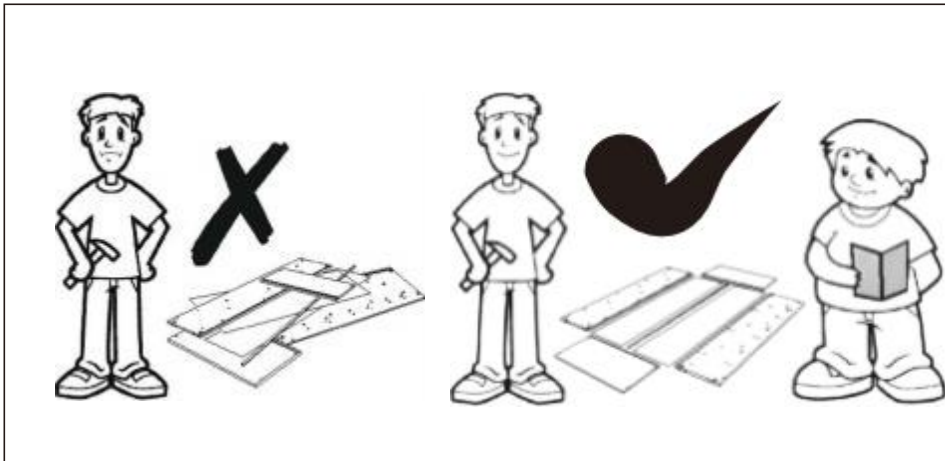

matters needing attention



Q1540 Panel List

B1 Small tabletop panel*1	B5 Large tabletop panel*1
B2 Upper connecting panel*1	B6 Table leg*3
B3 Cylindrical leg*1	
B4 Base panel*1	

Q1540 Installation Hardware & Tool List

H1190  Flat head Phillips screw 24 pcs	H1511  Gasket M8*18 24 pcs	H2525  Single glue felt pad 10 pcs	
--	--	--	--

