

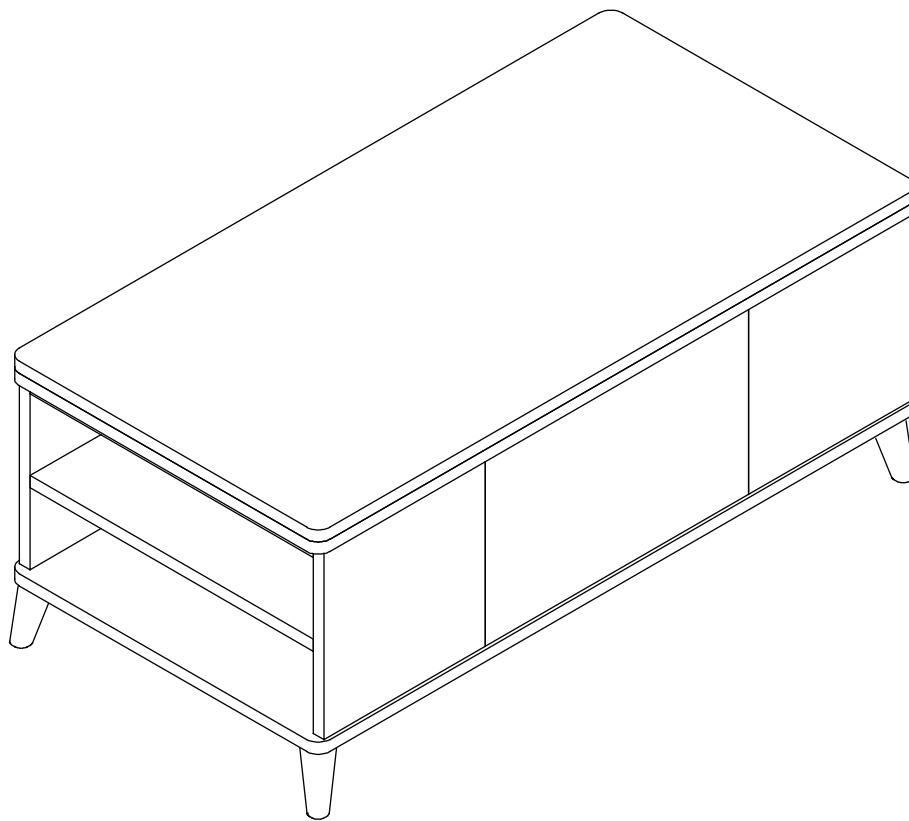

Coffee Table



CUSTOMER FIRST INTEGRITY

QEZEOMService@outlook.com

GuideTo Assembly Model:G5072HW

Thank you for purchasing this product. Please read these instructions fully before starting assembly, then follow the simple step by step guide.

TOP TIPS BEFORE YOU START!

1. Please check that all parts & hardware are present before you start the assembly of your furniture. Do not destroy any of the packaging until you are certain that you have all the necessary parts for assembly.
2. For ease and speed of assembly, we recommend that before you commence each step of the assembly, please identify all the parts required for that step.
3. We recommend that where possible, all items are assembled near to the area in which they will be placed in use, to avoid moving the product unnecessarily once assembled.
4. For the protection of your furniture, particularly items of high gloss finish, we recommend that the product is placed on a protected surface during assembly to prevent any damage.
5. During assembly please take care not to over-tighten any fittings, as this may damage the product.
6. Keep children and animals away from the work area, small parts could cause choking if swallowed.

Tools Required For Assembly



DO NOT USE POWER TOOLS TO ASSEMBLE THIS PRODUCT. USE OF POWER TOOLS WILL INVALIDATE ANY CLAIM AND MAY DAMAGE THIS PRODUCT MAKING IT UNSAFE.

Rubber Hammer

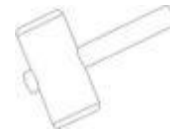

Self-provided general tool diagram:

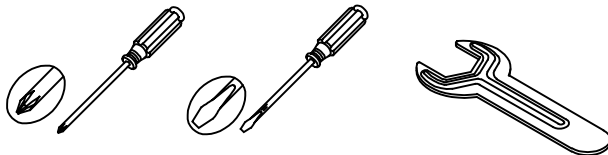

Tape Measure

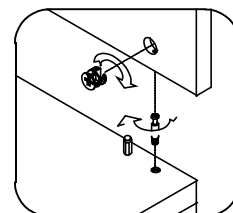
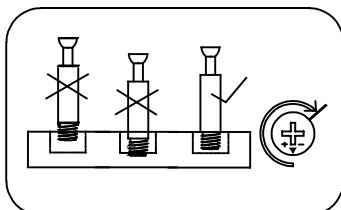

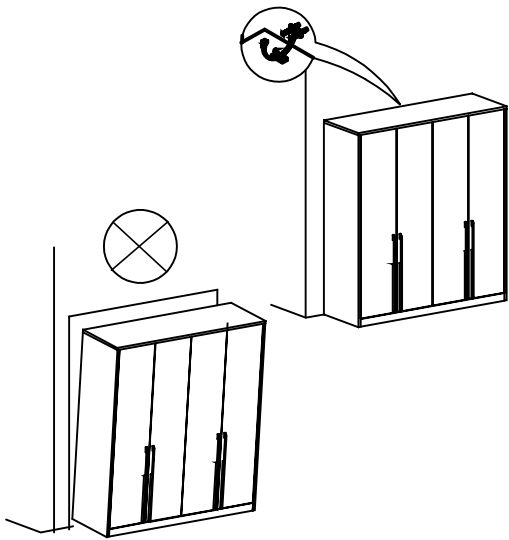

matters needing attention

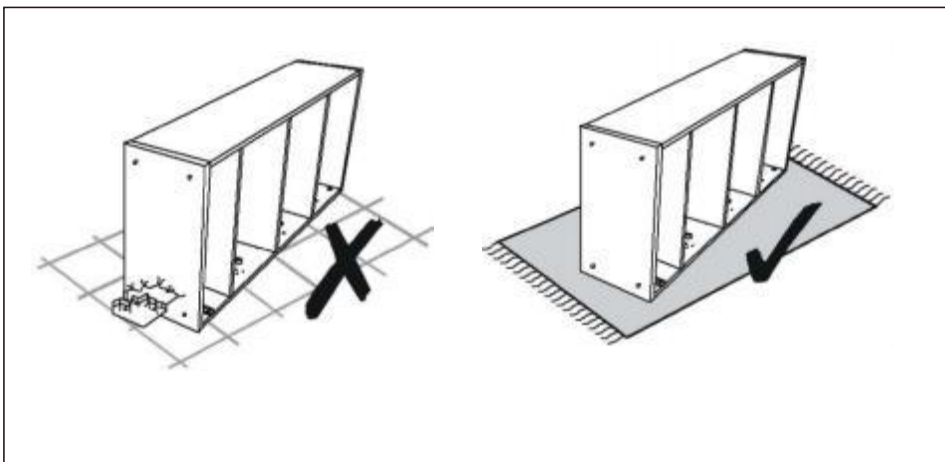
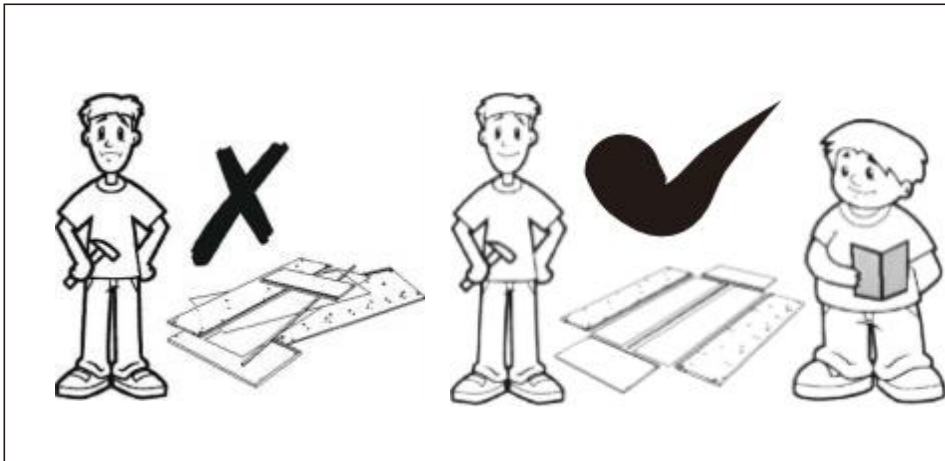

B1

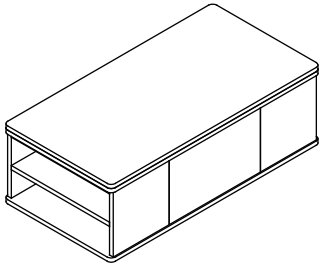

coffee table body 1pcs

B2



solid wood table legs

4pcs

B3



solid wood midsole

1pcs

Accessory box: W425、W110、H4159

其他

H1438

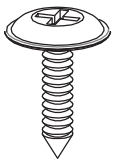

3.5*16

self-tapping screw (yellow) 35pcs

H2513



felt gasket 5pcs

H4159



Big three-in-one hole sticker gray 16pcs

H4107

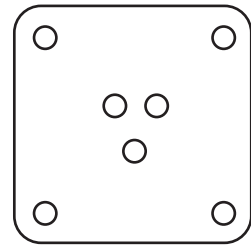

iron piece

5pcs

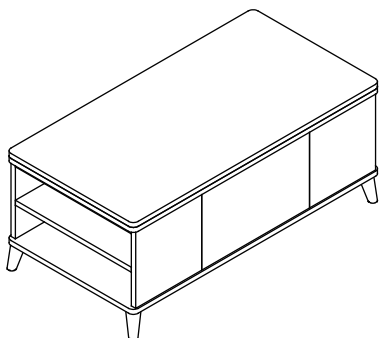
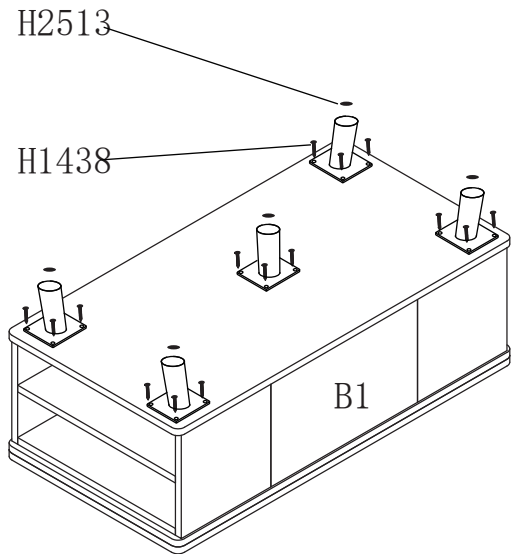
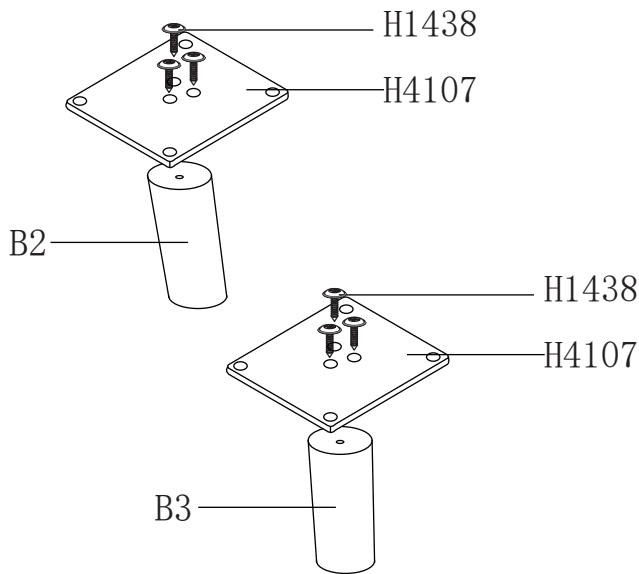

fully closed state

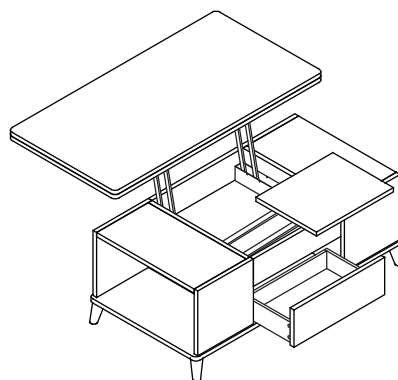

half-open state

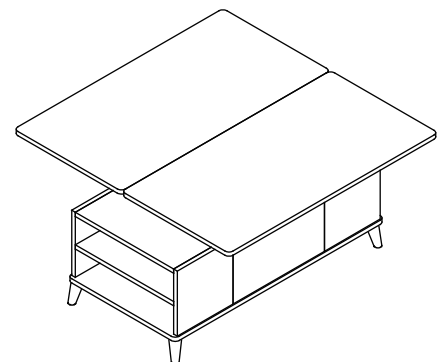

fully open state

Guide for Product Maintenance

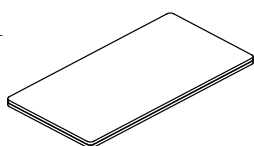
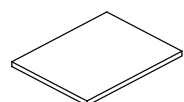
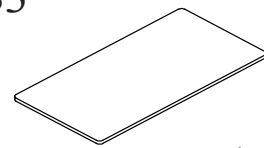
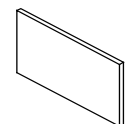
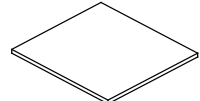
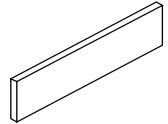
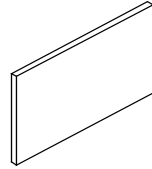
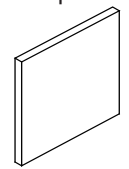
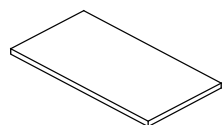
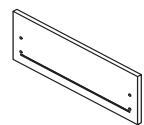
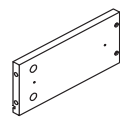
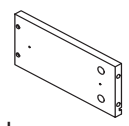
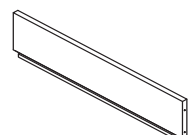
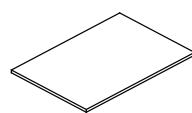
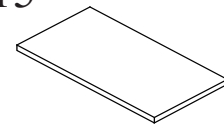
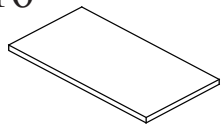
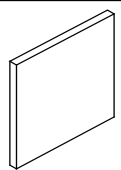
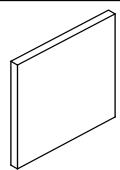
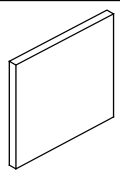
<p>B1</p>  <p>Large upper and lower panels 1pcs</p>	<p>B2</p>  <p>small panel 1pcs</p>	<p>B3</p>  <p>Bottom plate 1pcs</p>	<p>B4</p>  <p>Inner vertical panel 2pcs</p>
<p>B5</p>  <p>middle board 1pcs</p>	<p>B6</p>  <p>fake drawer front 1 pcs</p>	<p>B7</p>  <p>Backplane 1↑</p>	<p>B8</p>  <p>fake door panel A 1pcs</p>
<p>B9</p>  <p>Inner connecting plate 1pcs</p>	<p>B10</p>  <p>drawer panel 1 pcs</p>	<p>B11</p>  <p>Left drawer panel 1 pcs</p>	<p>B12</p>  <p>Right drawer panel 1pcs</p>
<p>B13</p>  <p>Backplane 1pcs</p>	<p>B14</p>  <p>Drawer bottom plate 1pcs</p>	<p>B15</p>  <p>After the inner connection board 1pcs</p>	<p>B16</p>  <p>small laminate 1pcs</p>
<p>B17</p>  <p>fake door panel B 1pcs</p>	<p>B18</p>  <p>fake door panel C 1pcs</p>	<p>B19</p>  <p>fake door panel D 1pcs</p>	

