

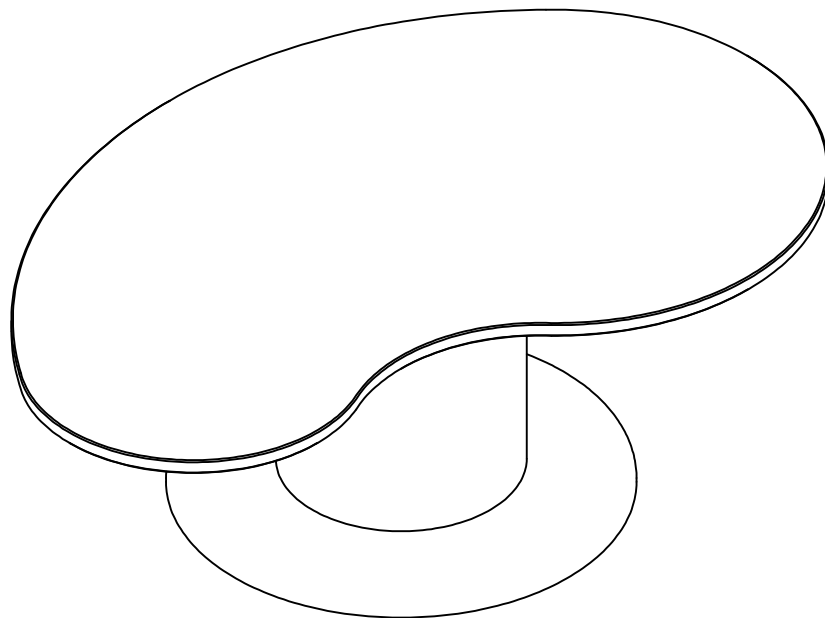

Coffee Table



CUSTOMER FIRST INTEGRITY

customer-service-24hour@outlook.com

GuideTo Assembly Model:L1737

Thank you for purchasing this product. Please read these instructions fully before starting assembly, then follow the simple step by step guide.

TOP TIPS BEFORE YOU START!

1. Please check that all parts & hardware are present before you start the assembly of your furniture. Do not destroy any of the packaging until you are certain that you have all the necessary parts for assembly.
2. For ease and speed of assembly, we recommend that before you commence each step of the assembly, please identify all the parts required for that step.
3. We recommend that where possible, all items are assembled near to the area in which they will be placed in use, to avoid moving the product unnecessarily once assembled.
4. For the protection of your furniture, particularly items of high gloss finish, we recommend that the product is placed on a protected surface during assembly to prevent any damage.
5. During assembly please take care not to over-tighten any fittings, as this may damage the product.
6. Keep children and animals away from the work area, small parts could cause choking if swallowed.

Tools Required For Assembly



DO NOT USE POWER TOOLS TO ASSEMBLE THIS PRODUCT. USE OF POWER TOOLS WILL INVALIDATE ANY CLAIM AND MAY DAMAGE THIS PRODUCT MAKING IT UNSAFE.

Rubber Hammer

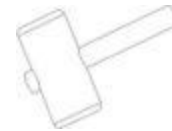

Self-provided general tool diagram:

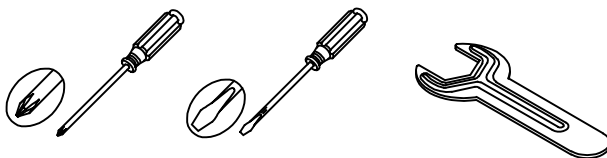

Tape Measure

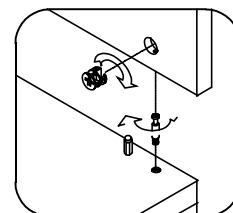
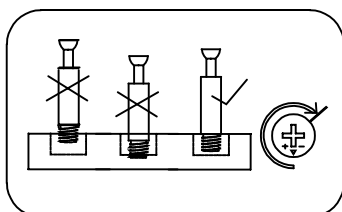

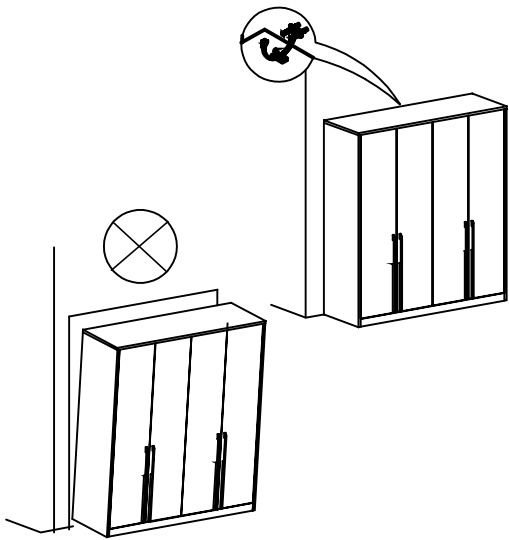

matters needing attention

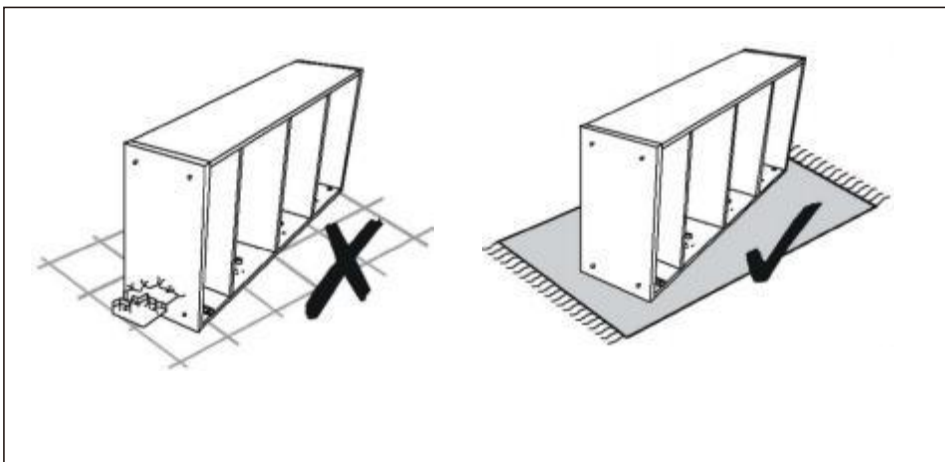
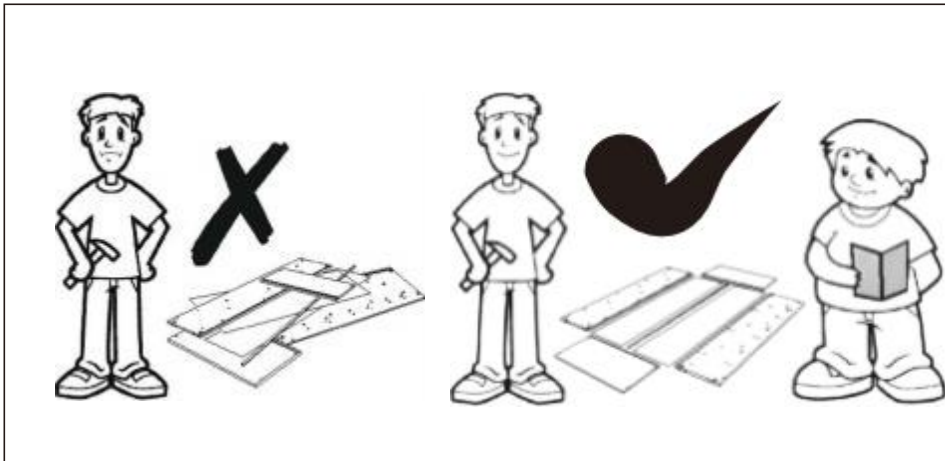

Hardwares for Assembly

HA0055

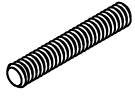

Screw Rod M8*400

2PCS

HA0083



Cross Lock Nut M8

2PCS

STEP 01

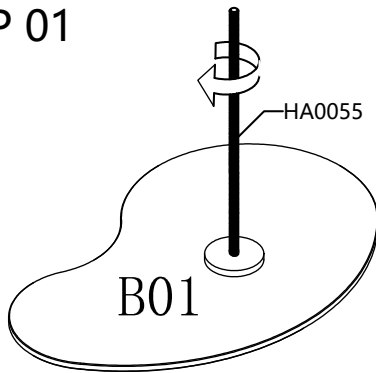

STEP 02

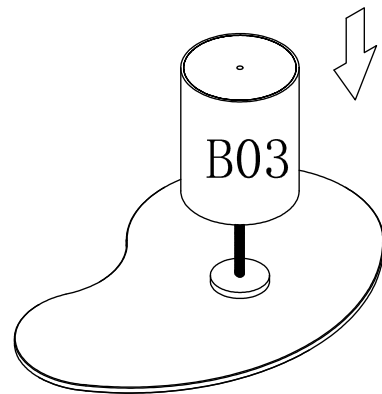

STEP 03

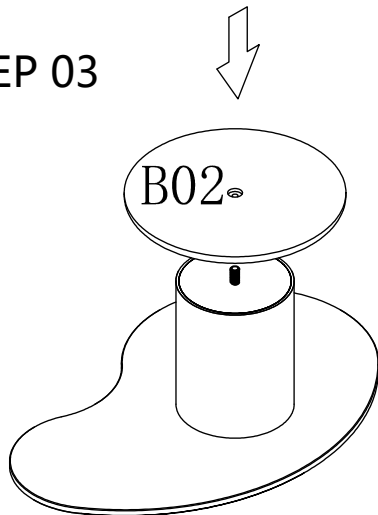

STEP 04

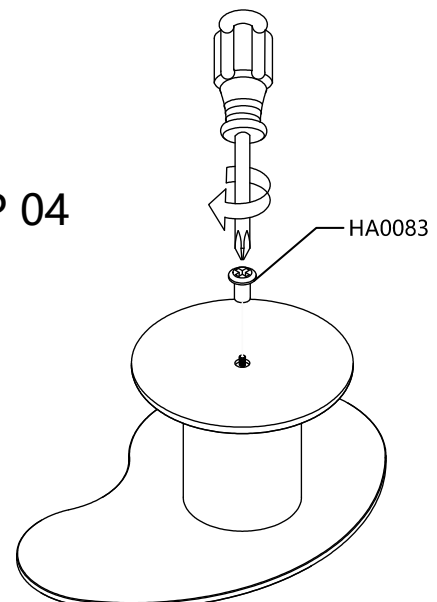

Guide for Product Maintenance

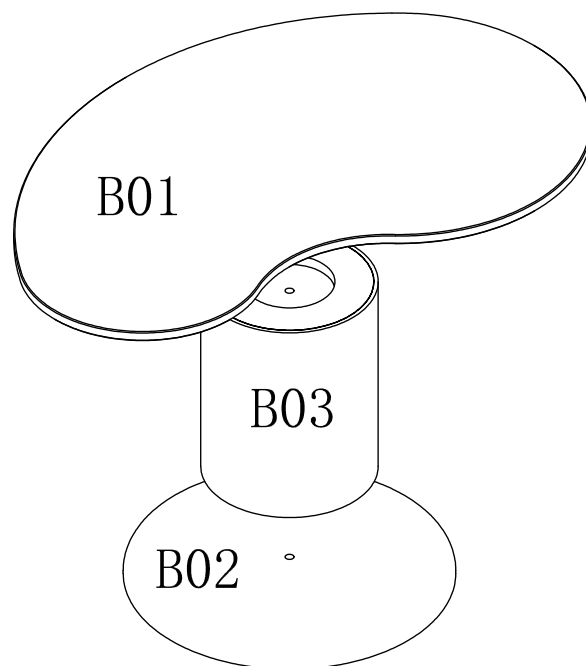

No.	Material	Qty
B01	Tabletop	1
B02	Base	1

No.	Material	Qty
B03	Support Column	1

No.	Material	Qty