

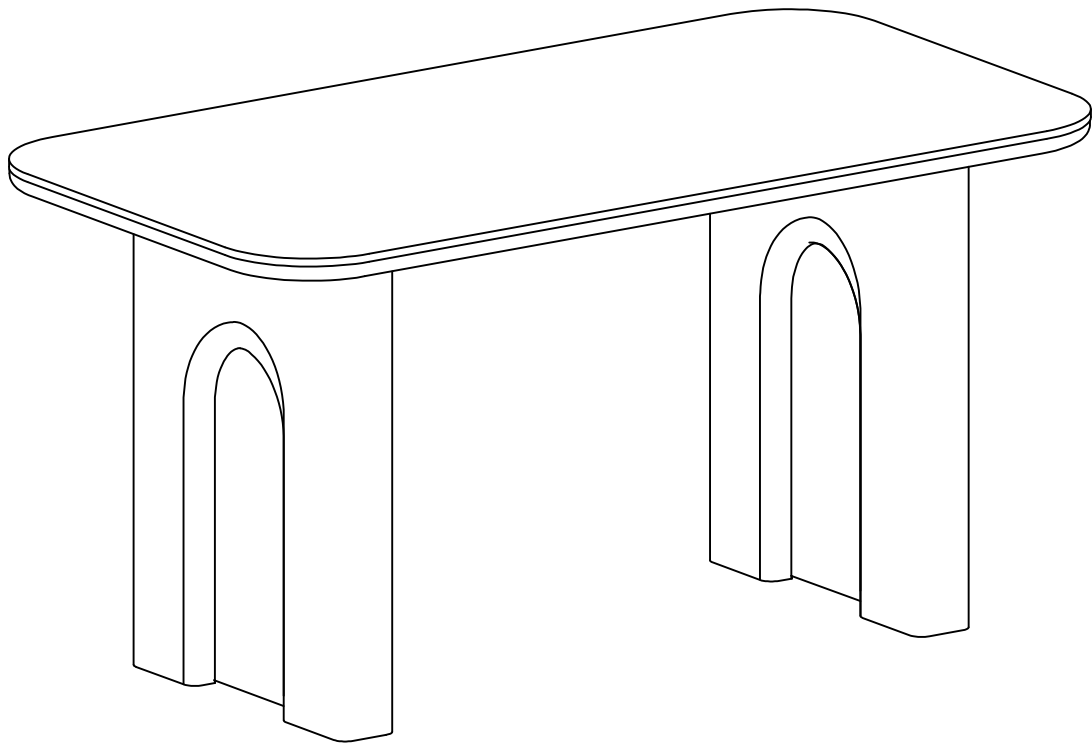

Dining Table



CUSTOMER FIRST INTEGRITY
customer-service-24hour@outlook.com

GuideTo Assembly Model:L1661

Thank you for purchasing this product. Please read these instructions fully before starting assembly, then follow the simple step by step guide.

TOP TIPS BEFORE YOU START!

1. Please check that all parts & hardware are present before you start the assembly of your furniture. Do not destroy any of the packaging until you are certain that you have all the necessary parts for assembly.
2. For ease and speed of assembly, we recommend that before you commence each step of the assembly, please identify all the parts required for that step.
3. We recommend that where possible, all items are assembled near to the area in which they will be placed in use, to avoid moving the product unnecessarily once assembled.
4. For the protection of your furniture, particularly items of high gloss finish, we recommend that the product is placed on a protected surface during assembly to prevent any damage.
5. During assembly please take care not to over-tighten any fittings, as this may damage the product.
6. Keep children and animals away from the work area, small parts could cause choking if swallowed.

Tools Required For Assembly



DO NOT USE POWER TOOLS TO ASSEMBLE THIS PRODUCT. USE OF POWER TOOLS WILL INVALIDATE ANY CLAIM AND MAY DAMAGE THIS PRODUCT MAKING IT UNSAFE.

Rubber Hammer

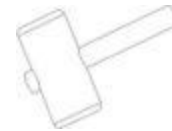

Self-provided general tool diagram:

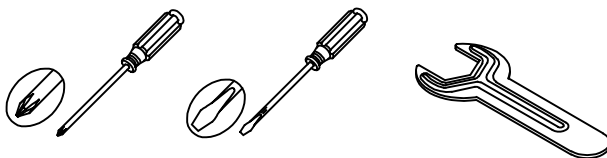

Tape Measure

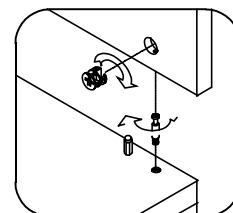
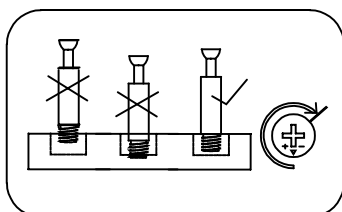

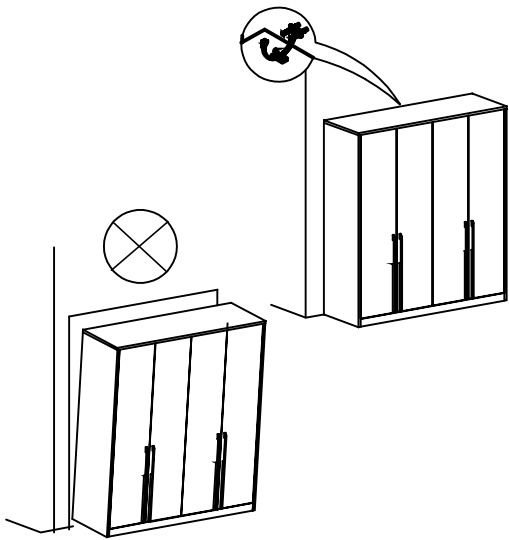



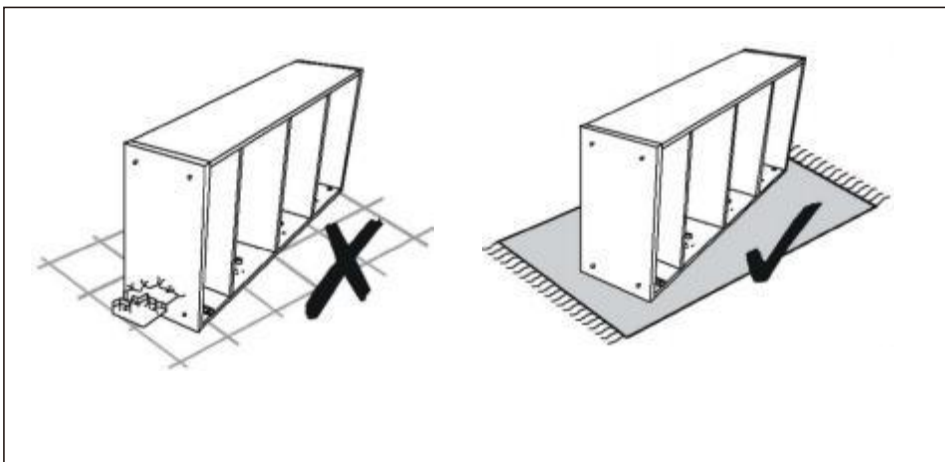
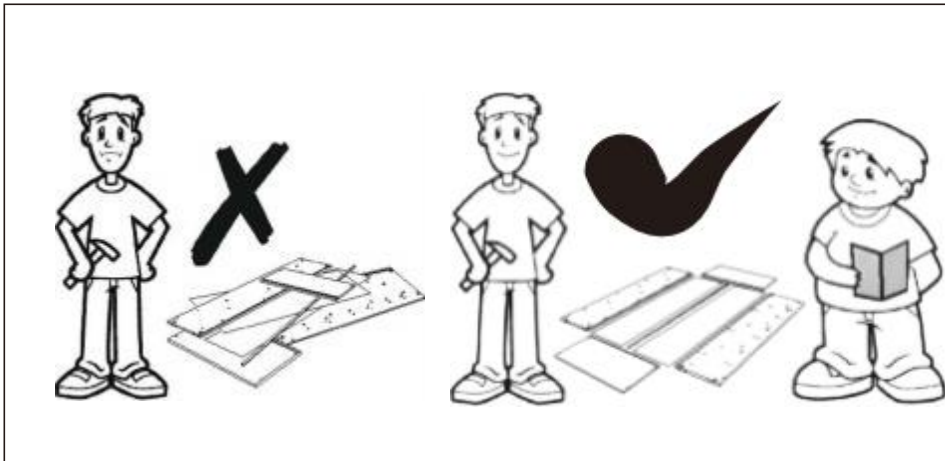

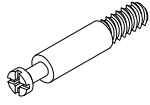

matters needing attention



Hardwares for Assembly

<p>H1201</p>  <p>Eccenter Φ 14.5*11.5 8 pcs</p>	<p>H1101</p>  <p>3-in-1 Connector Φ6*40 8 pcs</p>	<p>H5105</p>  <p>Internal Hexagon Wrench 5MM 1 pcs</p>	<p>H1511</p>  <p>Gasket M8*18 11 pcs</p>	<p>H1603</p>  <p>Felt Pad 30 8 pcs</p>	<p>H4108</p>  <p>Perfect Sticker 20 8 pcs</p>
<p>H1804</p>  <p>Flat Head Internal Hexagon Screw 8*75 3 pcs</p>	<p>H1130</p>  <p>Flat Head Internal Hexagon Screw 8*35 8 pcs</p>				

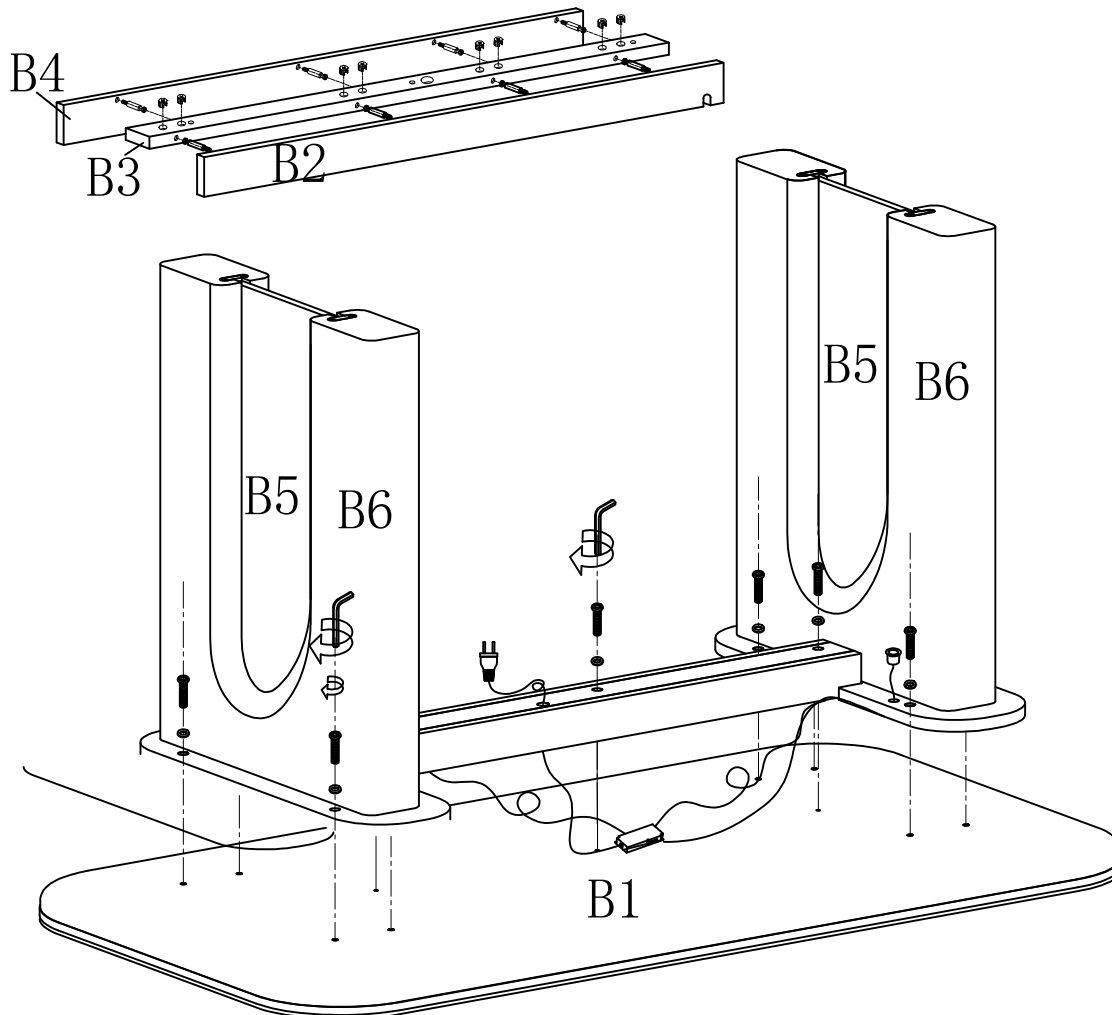

1. Assemble the Cable Management Panel with 3-in-1 Connectors first.



2. Check if there are any foreign objects on the surface of the foam. Place the tabletop facing downwards and align the legs properly. Align the legs with the holes in the tabletop and place them in place, then connect the lamp wires and power cords inside the legs to transformer. Thread the touch switch through the reserved hole and connect it to the transformer. Arrange the wires neatly and attach the cable management box to the top of the lamp assembly. Install the legs and cable management box together using screws. After installation, it is recommended to have at least two people flip the table to avoid scratching the paint.

Guidance for Product Maintenance

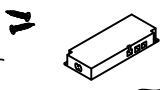
Bill of Material

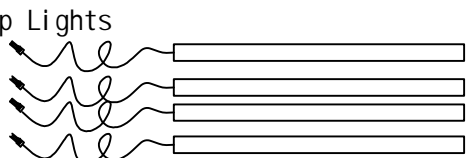
B1 Tabletop	 <p style="text-align: center;">Transformer</p>  <p style="text-align: center;">Touch Switch</p>  <p style="text-align: center;">220V Power Inlet</p>  <p style="text-align: center;">LED Strip Lights</p>
B2 Cable Management Panel	
B3 Cable Management Panel	
B4 Cable Management Panel	
B5 Arcylic*2	
B6 Leg*2	

B1 Tabletop

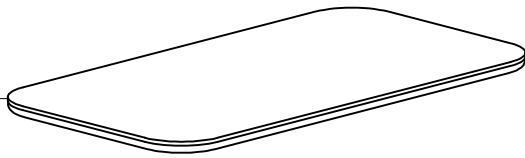

B2 Cable Management Panel

B2 Cable Management Panel

B4 Cable Management Panel

B5 Arcylic*2

B6 Leg*2

