

# PRODUCT CARE HANDBOOK

a guide to protecting your product

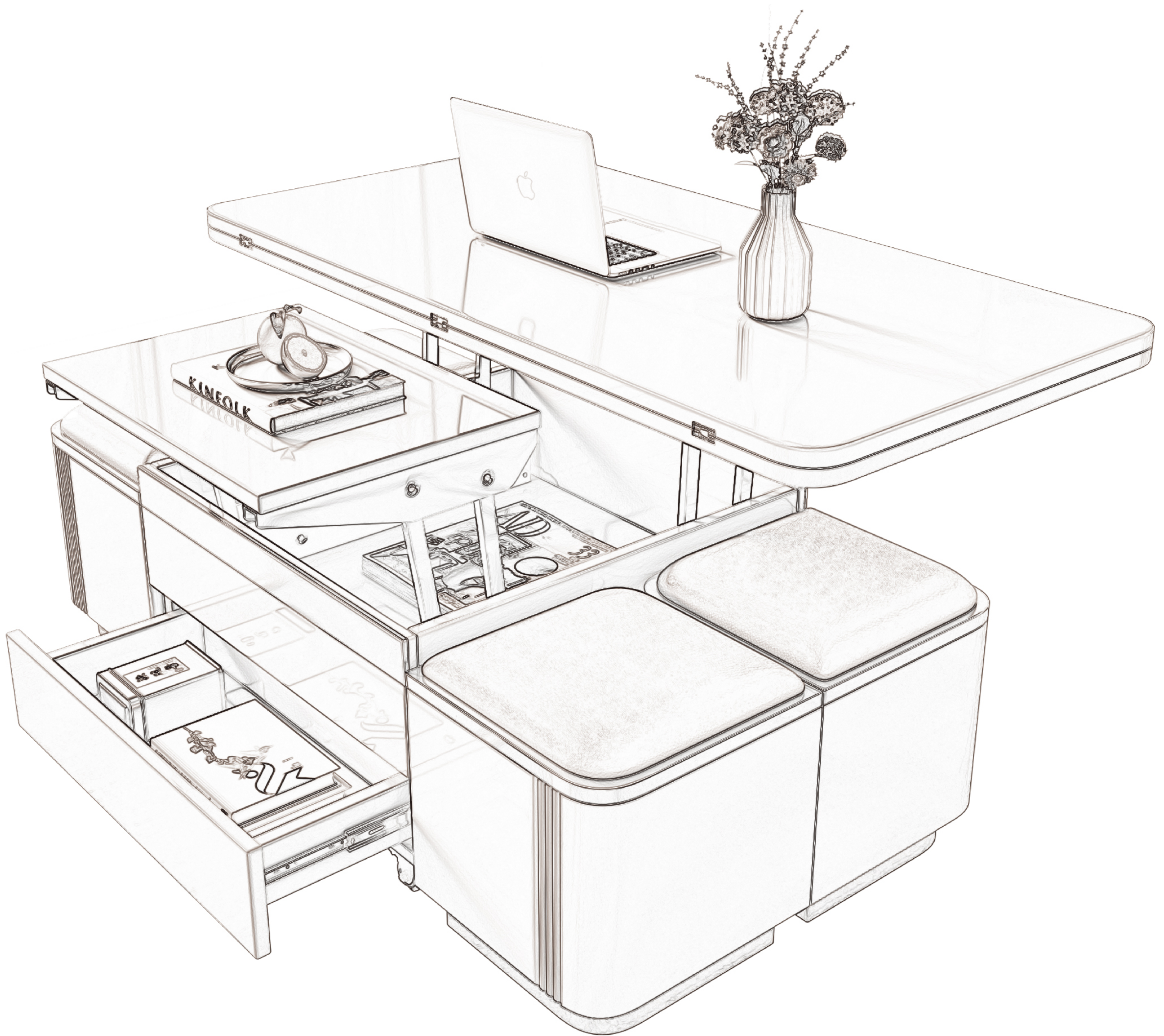

I'm made from 100%  
recycled paper



866-504-7728



support@guyii.com

www.guyii.com



### Coated with matte finish

Synthesize with varnish as main and matte agent as auxiliary

### The board is coated with polymer emulsion

As a base coat polished for 6 times

### Polishing undercoat

Polish with waterproof sandpaper and abrasive cloth

### Medium density fiberboard

Not easy to deform or crack

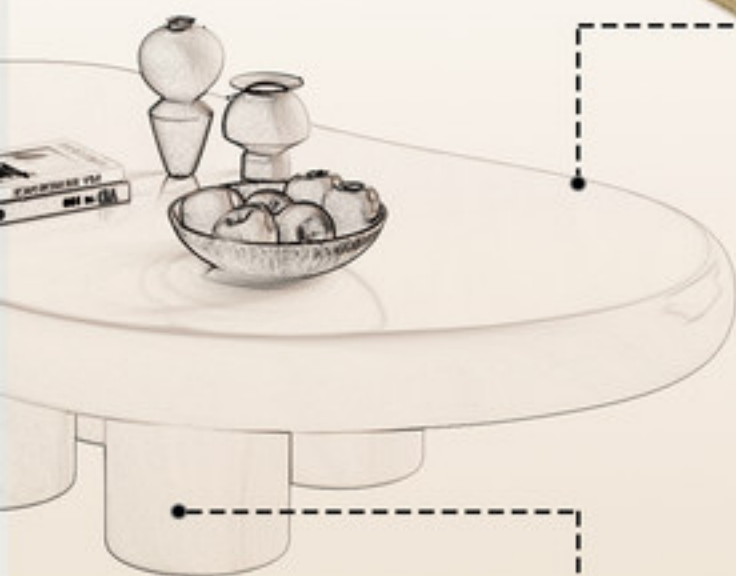

### Coated with matte finish

Synthesize with varnish as main and matte agent as auxiliary

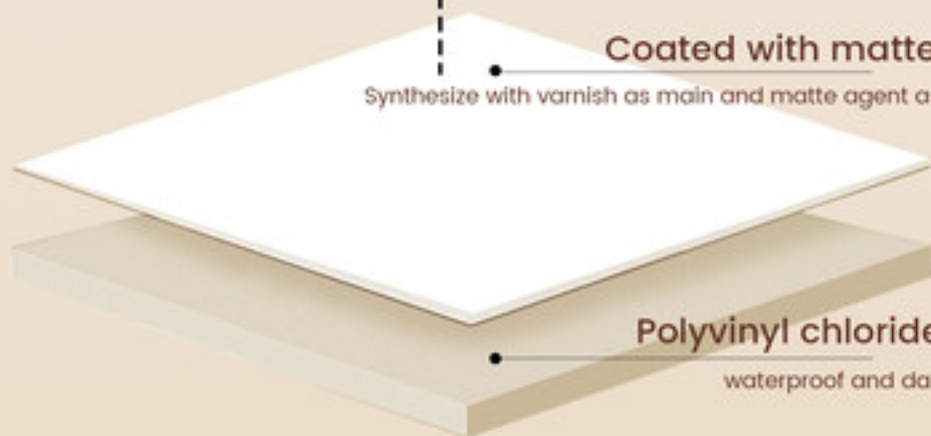

### Polyvinyl chloride base

waterproof and damp-proof

# GuideTo Assembly Model:Q1448

Thank you for purchasing this product. Please read these instructions fully before starting assembly, then follow the simple step by step guide.

## TOP TIPS BEFORE YOU START!

1. Please check that all parts & hardware are present before you start the assembly of your furniture. Do not destroy any of the packaging until you are certain that you have all the necessary parts for assembly.
2. For ease and speed of assembly, we recommend that before you commence each step of the assembly, please identify all the parts required for that step.
3. We recommend that where possible, all items are assembled near to the area in which they will be placed in use, to avoid moving the product unnecessarily once assembled.
4. For the protection of your furniture, particularly items of high gloss finish, we recommend that the product is placed on a protected surface during assembly to prevent any damage.
5. During assembly please take care not to over-tighten any fittings, as this may damage the product.
6. Keep children and animals away from the work area, small parts could cause choking if swallowed.

## Tools Required For Assembly



DO NOT USE POWER TOOLS TO ASSEMBLE THIS PRODUCT. USE OF POWER TOOLS WILL INVALIDATE ANY CLAIM AND MAY DAMAGE THIS PRODUCT MAKING IT UNSAFE.

Rubber Hammer

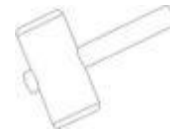

Self-provided general tool diagram:

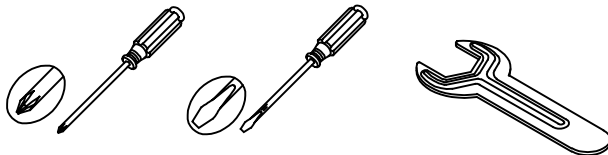

Tape Measure

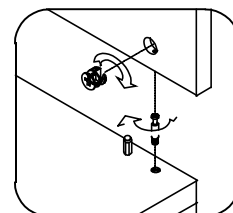
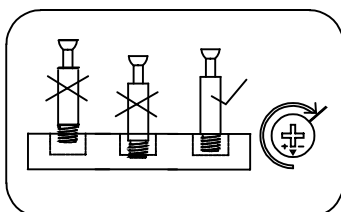

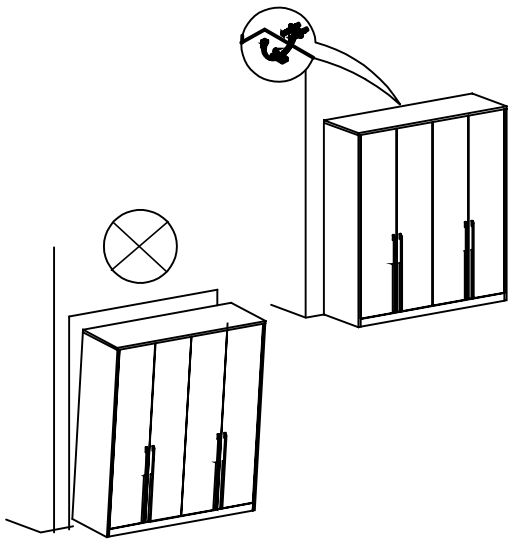

matters needing attention

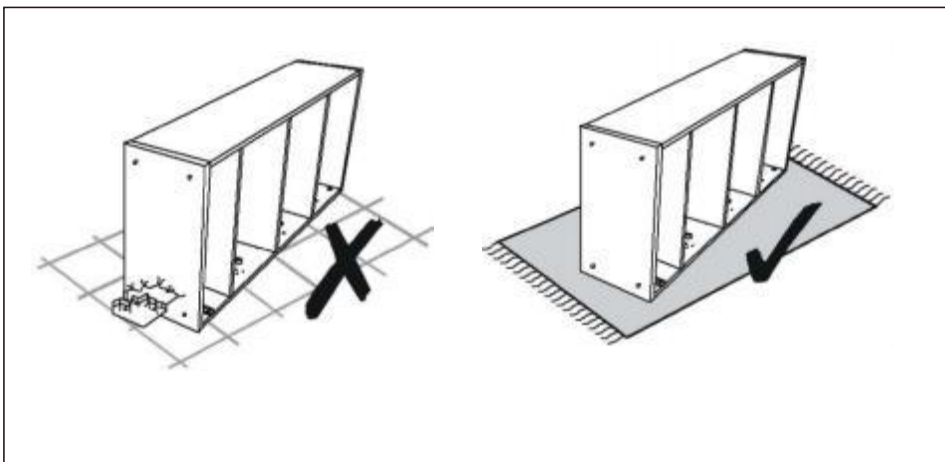
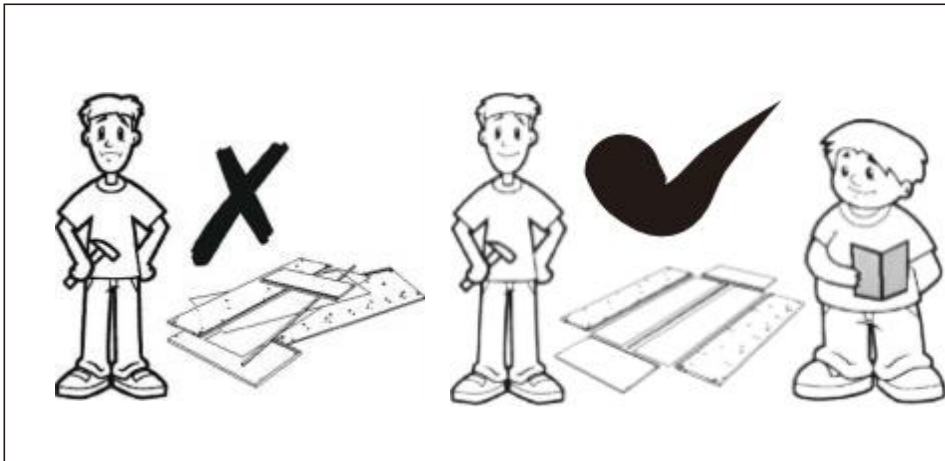

# Q1448 Installation Hardware List

H1417

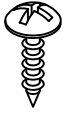

Umbrella head self tapping nail  
M5 \* 14

24PCS

H2601



Universal wheel with brake

4PCS

## Q1448 Installation Steps

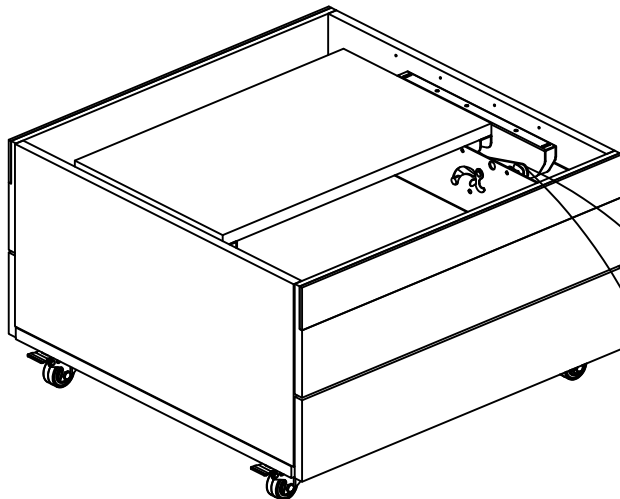
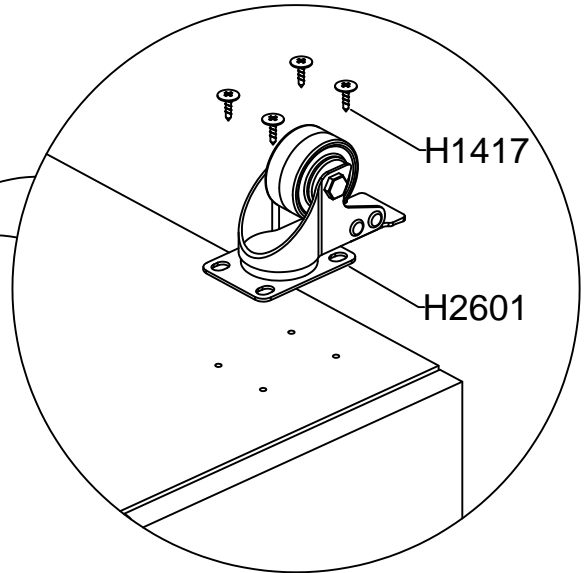
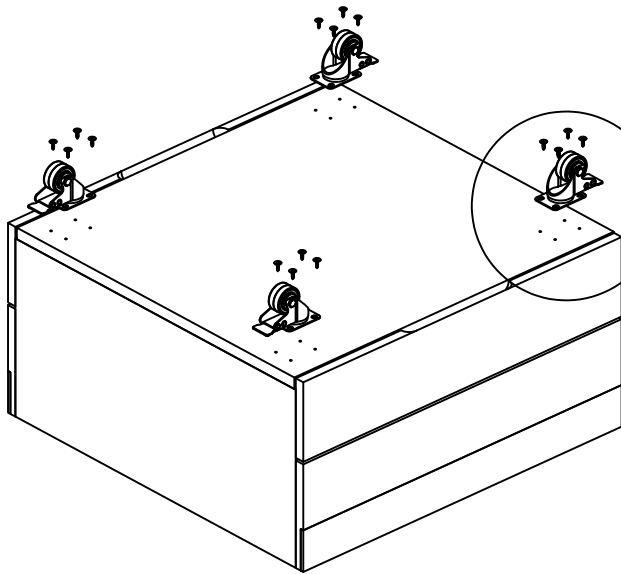

Disassemble the lifting frame and be careful to prevent it from bouncing up and injuring people



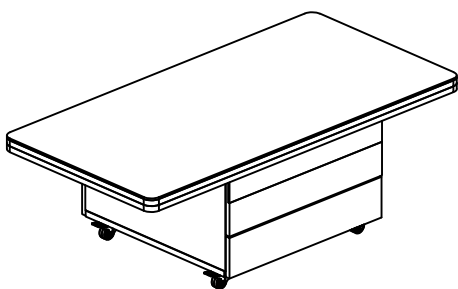
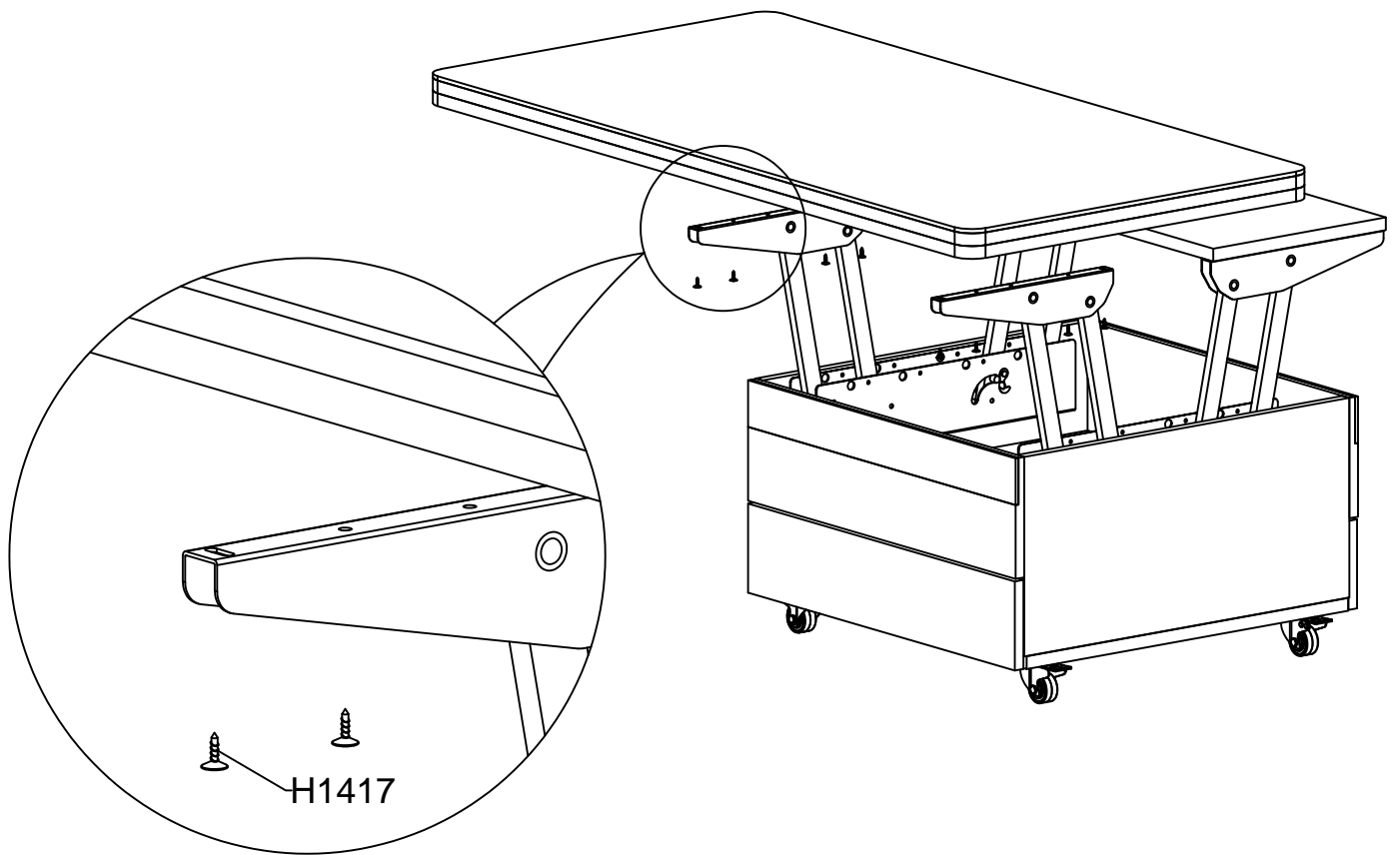

folding state

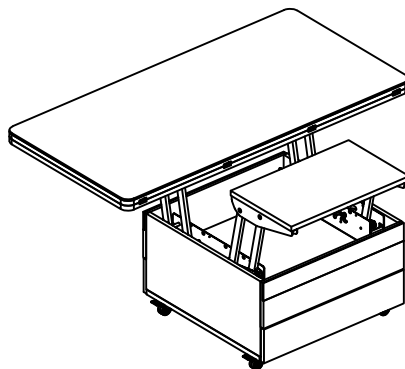



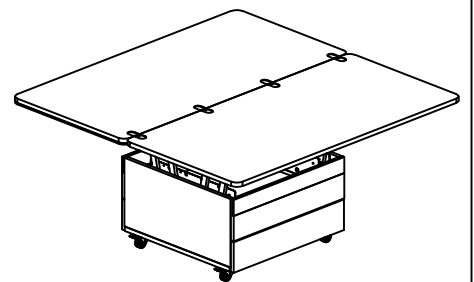





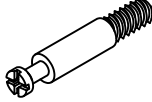

Semi unfolded state

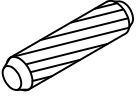
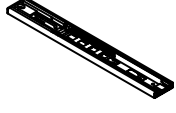

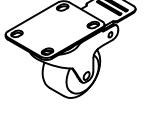
Fully expanded state

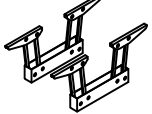
## Q1448 Maintenance Hardware List

<p>H1721</p>  <p>Plastic embedded nuts 42PCS</p>	<p>H1201</p>  <p>Eccentric wheel Φ14.5*11.5 42PCS</p>	<p>H1101</p>  <p>Three in one pole Φ6*40 42PCS</p>	<p>H1403</p>  <p>Self tapping screw M3.5 * 16 24PCS</p>
<p>H1113</p>  <p>Wood pin M8 * 40 10PCS</p>	<p>HB0009</p>  <p>Three section slide rail black 10 inch 45 wide 2PCS</p>	<p>H1417</p>  <p>Umbrella head self tapping nail M5 * 14 48PCS</p>	<p>H2601</p>  <p>Universal wheel with brake 4PCS</p>
<p>H1335</p>  <p>Inner and outer nut (with intermediate) M6 * 13 8PCS</p>	<p>H6001(L)(R)</p>  <p>560 heavy-duty lifting frame 1PCS</p>	<p>H2211</p>  <p>Flip panel hinge 4PCS</p>	<p>H1443</p>  <p>Self tapping screw M3.5 * 14 20PCS</p>

## Q1448 Repair Panel List

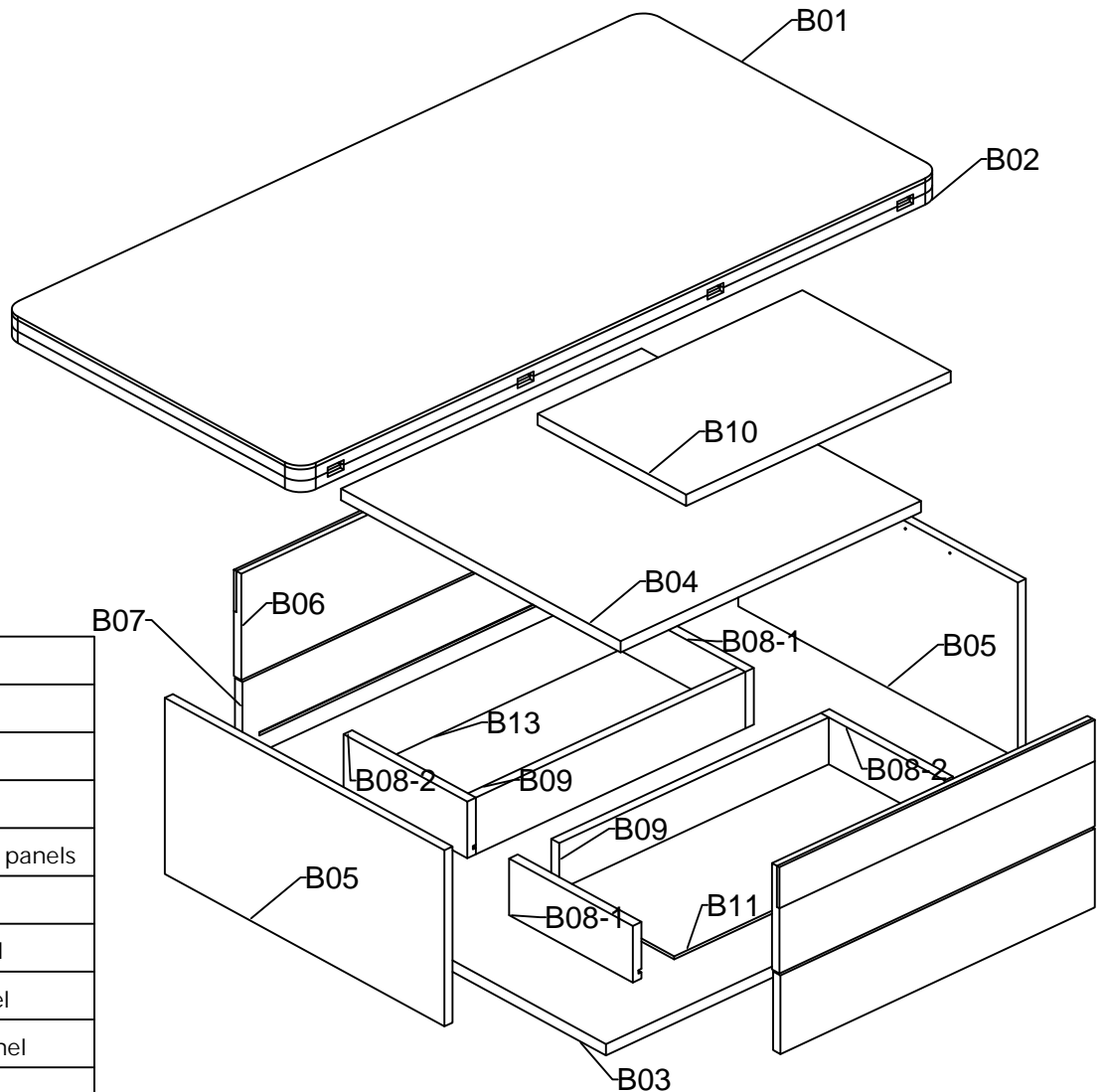

B01*1 Upper panel
B02*1 Lower panel
B03*1 baseplate
B04*1 Partition board
B05*2 Left and right side panels
B06*2 Fake drawer door
B07*2 Drawer door panel
B08-1*2 Drawer left panel
B08-2*2 Drawer right panel
B09*2 Drawer tail panel
B10*1 Pallet
B11*2 Drawer bottom plate

# WE'RE HERE TO HELP

how to get in touch with us



866-504-7728

---



support@guyii.com

---